



40 Huntingwood Drive Huntingwood NSW 2148

Phone: (02) 8825 1999 Website: www.aeroflowperformance.com

AEROFLOW PERFORMANCE

76 LITRE FUEL CELL WITH TRIPLE PUMP HANGER

WARNING!

BEFORE PROCEEDING WITH INSTALLATION PLEASE READ INSTRUCTIONS CAREFULLY. THIS PRODUCT REQUIRES DETAILED KNOWLEDGE OF AUTOMOTIVE SYSTEMS. WE RECOMMEND THAT THIS INSTALLATION BE CARRIED OUT BY A QUALIFIED AUTOMOTIVE TECHNICIAN.

THE INSTALLATION OF THIS PRODUCT REQUIRES THE HANDLING OF FUEL. WE RECOMMEND TO WORK IN A WELL VENTILATED AND WEAR APPROPRIATE SAFETY WEAR FOR PROTECTION.

KEEP ALL IGNITION SOURCES AND OPEN FLAMES AWAY FROM VEHICLE AT ALL TIMES WHILE INSTALLING THIS PRODUCT.

THESE SURGE TANKS UTILIZE O-RING SEALED AN STYLE PORTS AND DO NOT REQUIRE THREAD SEALANT ONLY AN APPROPRIATE LUBRICATE SHOULD BE USED

INTRODUCTION

Congratulations on your purchase of Aeroflow Performance 76 Litre (20 gallon) flat bottom fuel cell with billet triple pump hanger pre-installed. Aeroflow Performance products cannot and will not be responsible for any damage, or other conditions resulting from misapplication of the parts described herein. However, it is our intention to provide the best possible products for our customer, products that perform properly and satisfy your expectations. Should you have any questions? Please call technical support at +61 2 8825 1900 and have the product part number on hand when calling.

This Aeroflow Performance fuel cell is made from 3.0mm high grade aluminium. The dimensions of this tank are: Length = 510mm (20-1/16"), Width = 620mm (24-3/8"), Height 260mm (10-1/4"). We recommend if using alcohol or ethanol-based fuels to use the black anodised tanks.

It features a flat bottom for easy installation into tight spacers, also included is internal baffling to help prevent fuel starvation. Some applications may require the use of a surge tank fitted alongside this fuel cell. Please contact a professional if you are unsure about your fuel system.

This fuel cell comes with a billet flush cap (**F**) with a flip up and twist action, a one way air valve is also designed into the cap. A screw on cap assembly and remote filler cap is available separately if you wish to run an external fill point instead of the fuel cell (AF85-3000 or AF85-2002)

A fuel level sender (**D**) is included in this fuel cell and is 0 ohms empty, 90 ohms full resistance . Please check your original sender unit ohm range or aftermarket gauge instructions to ensure correct resistance. If this is not the same it will not read the correct level fuel in the fuel cell. When wiring up fuel sender ensure to use appropriate wiring and terminals. The (**S**) marked terminal is the signal wire that should be wired into the fuel gauge and the (**G**) marked terminal can be wired anywhere to a good ground.

This fuel cell requires the use of a vent / rollover valve (AF613-12 sold separately) in order to breathe correctly and not over pressurize and cause damage to the fuel cell. It is recommended that the vent hose is run off the fuel cell vertically into the air 6"-12", make one or two loops in the line and run it out of the car. When this line is out of the car ensure it is away from extreme heat sources and moving components, an air filter attached to this line is recommended to catch flumes etc. The vented fuel cap is not a sufficient standalone vent for this fuel cell.

This fuel cell features our CNC machined billet triple pump hanger (**E**) that is designed to suit 3x 60mm diameter fuel pump/s (AF49-1013 sold separately). The Buna N O-ring provides a positive seal for the internal fuel log which has a large female -12AN O-ring feed and female -8AN O-ring return. With 3x-8AN internal feeds along with check valves and male to female joiners which remove the need for in-tank hose or clamps. Please refer to the instructions for fitment.

This fuel cell is only one component of your vehicles complete fuel system. Please ensure the vehicles complete fuel system is up to the task of supplying the right amount of fuel to your engine. Failure to do so may result in severe engine damage and damage to other related components.

MOUNTING

- When mounting this surge tank ensure it is on a stable and structural location.
- Ensure when mounting tank to provide enough support underneath when the tank is full
- Make sure there are no sharp edges or objects near the fuel cell that could penetrate in an event of an impact.
- Rubber mounts are recommended when mounting fuel cell to vehicle. Ensure to utilize all 4 mounting tabs when mounting this fuel cell.
- Recommended to mount away from excessive heat, moving components and collision prone areas

PLUMBING/WIRING FUEL CELL WITH BILLET HANGER

- This fuel cell features two female -12AN O-ring bungs (**B**) welded to it and are designed for return breather line/s
- The billet triple hanger has one female -12AN O-ring (**A**) designed for the feed line to the engine
- The billet triple hanger has one female -8AN O-ring (**C**) designed for the return from the engine/regulator
- Remove the billet hanger assembly from the fuel cell via the 12 socket cap screws.
- To fit the fuel pump/s to the hanger
 - I. Attach the fuel pumps / check valves to the swivel fittings.

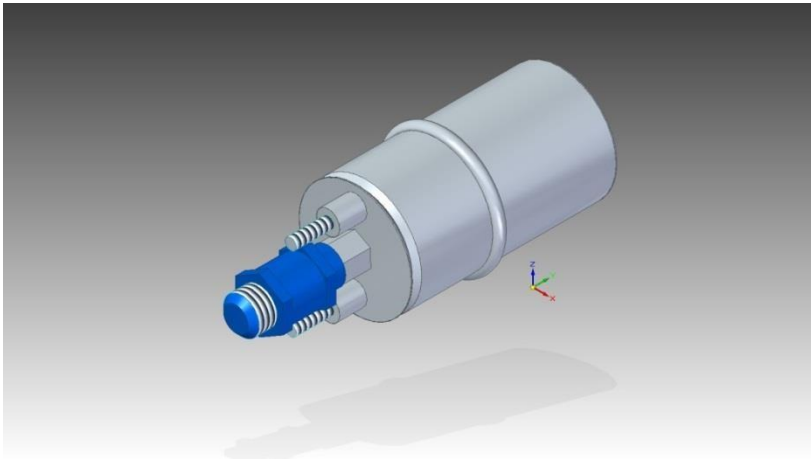

- II. Fit the pump retaining bracket and bolt to the spacer using the supplied M6 18mm UHL cap screw. Use the 3 remaining M6 18mm UHL cap screws to secure the pumps.

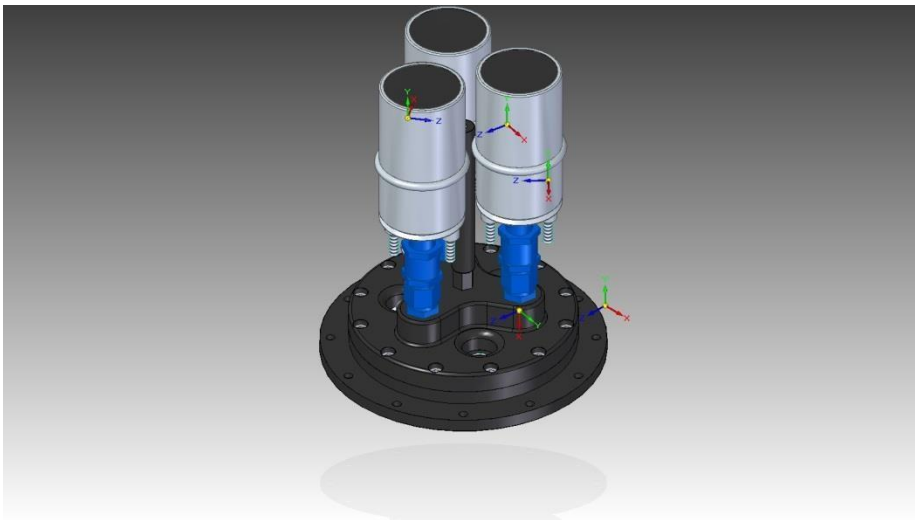

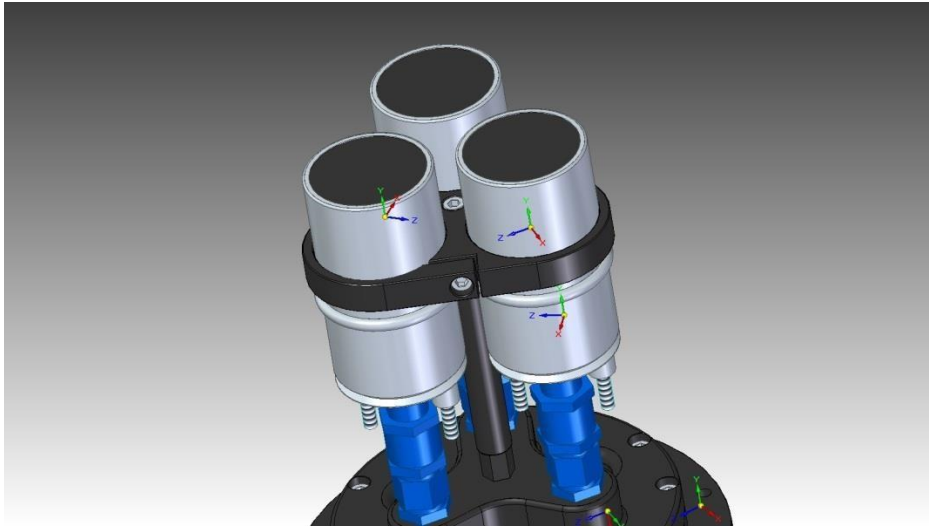

- III. **NOTE:** If you are using only one or two pumps, replace the swivel fitting with a -8ORB port plug (Not supplied with kit) Fit the check valves to the fuel pump inlets.

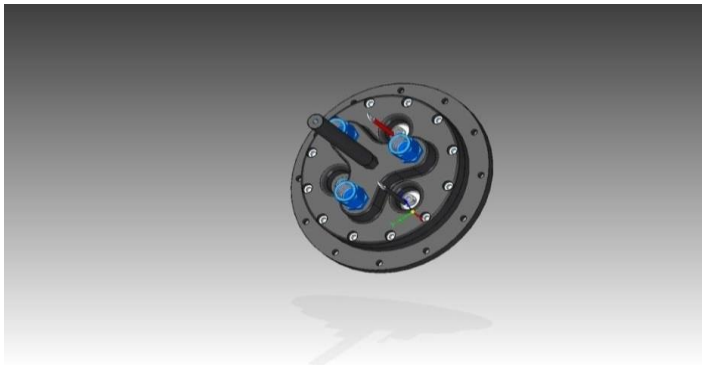

- To wire in the fuel pump/s in the billet hanger
 - I. Bend one end of the long red and black wires 90 degrees and assemble as shown below with a 6mm O-ring, a wiring insulator and a 14mm O-ring.
 - II. Fit to the top plate with another 14mm O-ring, wiring insulator, flat washer and m6 Nut.

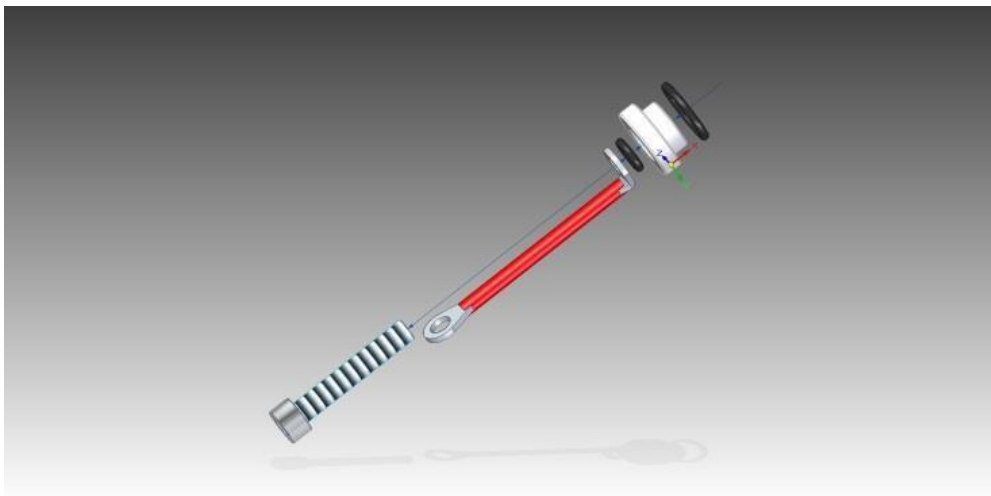

- III. Using the supplied M6 stud attach the spacer and then fit the 3 swivel fittings.

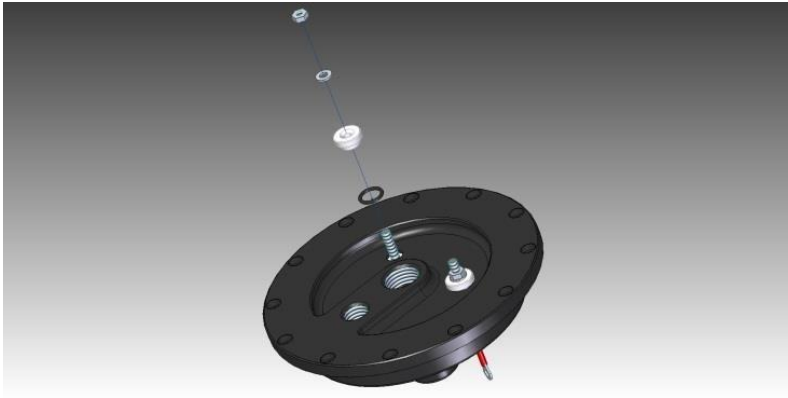

IV. Connect the wiring to the first pump and using the supplied short wires connect the first pump to the second and third pumps. If you're unsure of the correct way to wire the pumps please consult an auto electrician.

- Once the billet hanger assembly is all together it can be installed and secured with 12 x M6 18mm UHL socket cap screws, using the 170mm I.D. O-ring to seal it. Ensure these screws are torqued to 8-9 ft-lb to avoid any damage to tank and hanger.
- Connect the wiring to the external terminals and hold in place using the supplied M6 nuts.

Failure to follow any of the above may result in fuel leakage, bursting of fuel lines, poor vehicle performance and/or decreased fuel pump life.

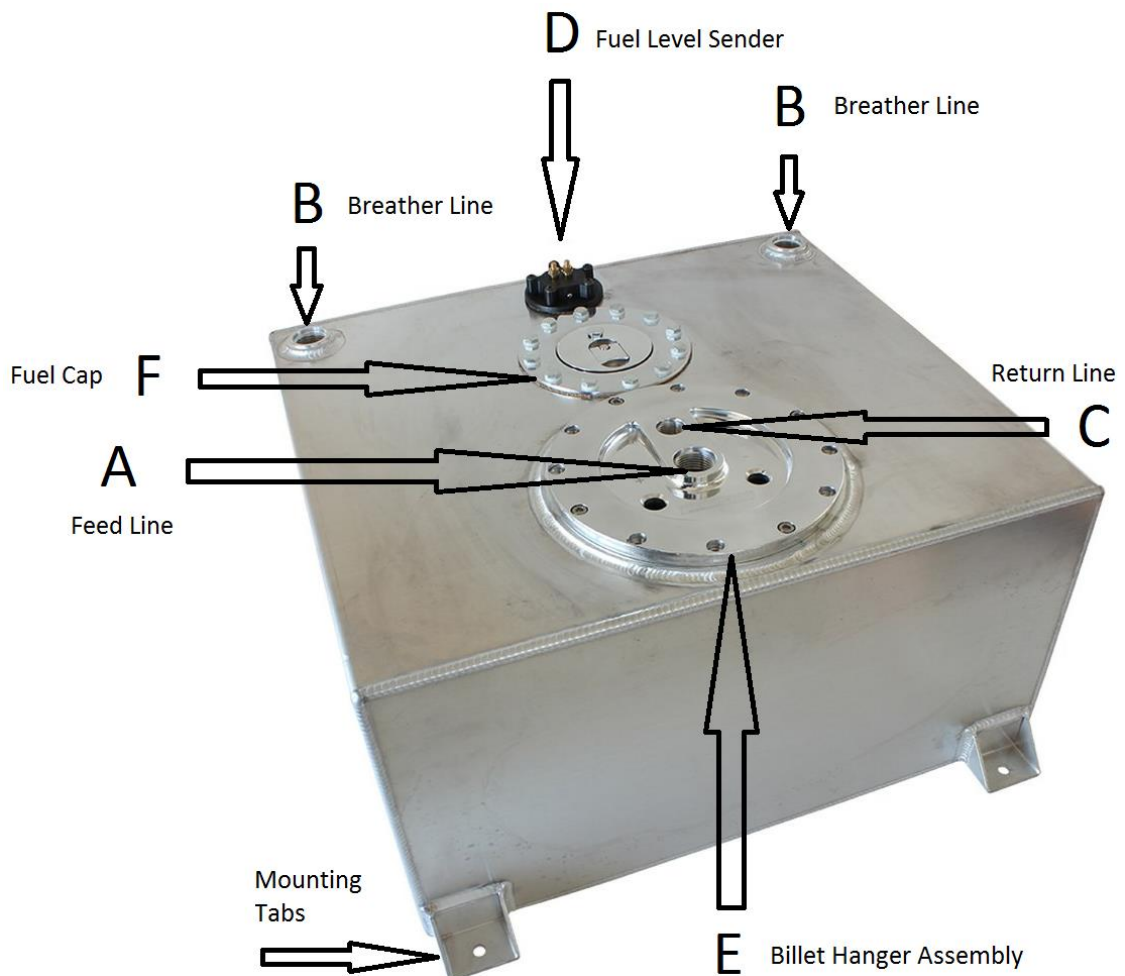

For more information or technical enquires

Contact: Aeroflow Performance on

Phone: (02) 8825 1979 Website: www.aeroflowperformance.com



BAFFLES INSIDE FUEL CELL



BILLET TRIPLE PUMP HANGER ASSEMBLY WITH FUEL PUMPS INSTALLED

For more information or technical enquires

Contact: Aeroflow Performance on

Phone: (02) 8825 1979 Website: www.aeroflowperformance.com