



40 Huntingwood Drive Huntingwood NSW 2148

Phone: (02) 8825 1999 Website: www.aeroflowperformance.com

AEROFLOW PERFORMANCE

ELECTRIC FAN

WARNING!

THIS PRODUCT REQUIRES DETAILED KNOWLEDGE OF AUTOMOTIVE SYSTEMS. WE RECOMMEND THAT THIS INSTALLATION BE CARRIED OUT BY A QUALIFIED AUTOMOTIVE TECHNICIAN.

INTRODUCTION

Congratulations on your purchase of Aeroflow Performance universal electric fan. Aeroflow Performance products cannot and will not be responsible for any damage, or other conditions resulting from misapplication of the parts described herein. However, it is our intention to provide the best possible products for our customer, products that perform properly and satisfy your expectations. Should you have any questions? Please call technical support at +61 2 8825 1900 and have the product part number on hand when calling.

The Aeroflow performance universal electric fans are suitable for both A/C condenser, radiator cooling or can be mounted to any fluid cooler. These fans provide constant air flow, increased fuel economy, better air conditioning performance, cooler engine running, and increased engine power.

All electric fans are powered via 12 volts and can be used with any fan controller (sold separately). All electric fans are fully reversible blades and polarity for mounting either side of the heat exchanger. They are boxed in the puller configuration. To change this to a pusher fan simply unscrew 10mm nut (reverse (left hand) thread) and turn fan blade over keeping in mind polarity BLUE - Positive BLACK - Negative.

The electric fans are packaged with the fan assembly (motor, fan blade, shroud), fan fitting/mounting hardware is included. All wiring and controllers are sold separately.

Dimensions/Specifications of this fan are:

- Fan Blade – 178mm (measured from fan blade end to end not the mounting points or fan shroud)
- Fan Mounting – 215mm
- Thickness from Mounting surface to Flat Section of Motor – 50.8mm
- Thickness from Mounting surface to Nose Section of Motor – 62.2mm
- Current Draw – 10 Amps @ 13.4 Volts
- Fan Flow – 550 CFM

This electric fan is factory setup for PULLER applications

To change the airflow direction from the factory setting or to a PUSHER follow the flowing steps:

1. Remove the Nut that holds the electric fan blade onto the motor shaft.
 - I. Note: this is left hand (reverse) thread nut.
2. Carefully remove the fan blade from the motor shaft. This is an interference fit and requires some effort.
3. Flip the fan blade upside down and reinstall onto the motor shaft. Make sure the roll pin on the motor shaft is aligned with the slot on the fan blade.
4. Reinstall nut on motor shaft. For Pusher applications the two wires MUST be reversed to change airflow direction.

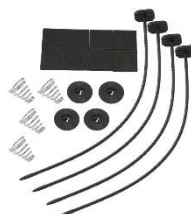

INSTALLATION GUIDELINES

Ensure no obstruction when fitting / mounting fan/s in position - engine pulley/s belts, bonnet etc. Then spin by hand for correct clearance before operating. To confirm airflow and direction of airflow which **MUST** flow through the grill/vehicle use a piece of paper to check this.

MOUNTING OF FAN

1. Remove the original belt driven fan and shroud (if applicable). After removing fan from the pulley, replace the bolts in the water pump hub. You may need washers (not provided) to replace the thickness of the belt driven fan.
2. Decide which surface of the radiator you wish to mount the fan(s). If you are fitting two fans it may be necessary to fit the larger of the two on one side and the smaller on the opposite side of the heat exchanger, with as little overlap as possible.
3. Pay particular attention to the markings/arrows on the fan hub regarding the direction the fan should face.
 - I. **Note:** the direction of rotation is indicated by the arrow on the fan hub. Once the fan has been installed the arrow may not be visible.
4. Position the fan(s) directly on the surface of the heat exchanger. Take care that the fan and shroud does not foul any struts, engine pulleys, bonnet latches etc., including when the bonnet is closed.
5. Take the plastic rods provided and install through the mounting holes on the shroud pushing them slowly into and through the heat exchanger core.
 - I. Do not use excessive force when pushing plastic rods through radiator core. Excessive force could cause damage to the radiator fins and/or core.
6. Take the 1 x 1 foam pads provided and install them onto the plastic rods now protruding through the heat exchanger core.
7. Take the plastic clips provided, install onto the plastic rods and cinch them until the 1 x 1 Foam Pads are compressed.
8. Cut off the excess plastic rod.

WIRING OF FAN

Relay per fan **MUST** be used for **RELIABLE** operation of fan. (Sold separately AF49-1006)

Mount the relay in a secure place in the engine compartment away from heat sources.

Electric Fan should only be activated using a manual switch, thermostat and or electric fan controller (sold separately).

1. Disconnect the battery prior to wiring the electric fan
2. Attach the positive fan motor wire (BLUE) to a 12 V positive ignition-controlled source, e.g., fuse box.
 - I. **Note:** We recommend the use of a 20 Amp inline fuse (not included) for each fan
3. Attach the negative fan motor wire (BLACK) to a suitable ground
 - I. **Note:** Connect directly to battery negative terminal if possible
4. Reconnect the battery.

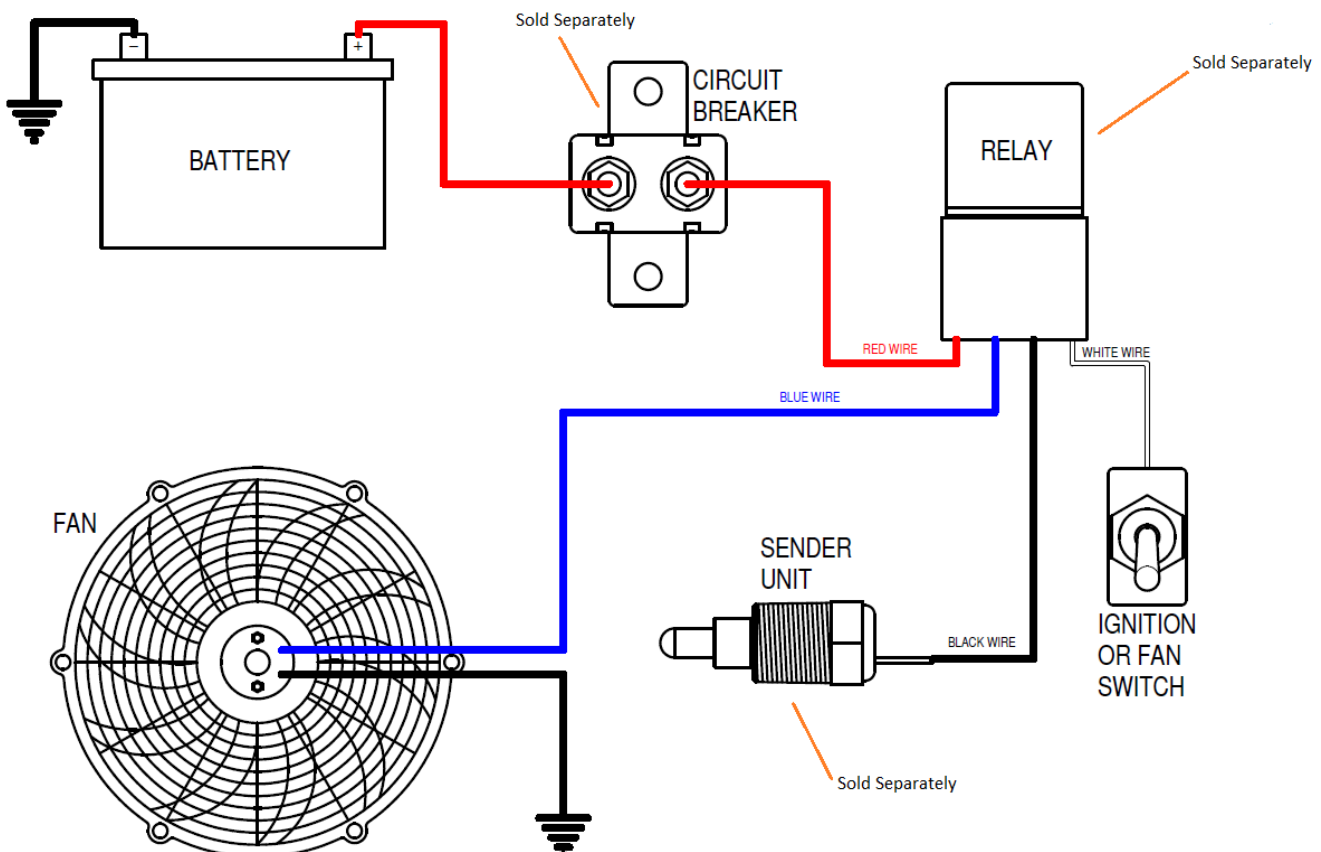

TROUBLE SHOOTING

The following notes are designed to help you overcome the most common problems experienced by customers with electric fans.

1. FAN RUNS NORMAL BUT ENGINE OVERHEATS CHECK:
 - A. Correct model fan is fitted.
 - B. Thermal switch is set correctly.
 - C. Fan blade facing the right way and rotating in direction.
 - D. Fan/s wired to full 12V power source.
 - E. Fan too far from radiator
 - F. Other cooling system problems.
2. FAN RUNS WHEN CAR TRAVELLING AT MEDIUM TO HIGH SPEEDS CHECK:
 - A. Adjustment of thermal switch.
 - B. Is the vehicle towing?
 - C. Other cooling system faults.
3. FAN DOES NOT RUN OR RUNS SLOWLY CHECK:
 - A. Fuses
 - B. Adjustment of thermal switch - Set too high!
 - C. Check wiring and correct polarity in correct positions.
 - D. Connect motor/s directly to battery then trace wiring towards switch if motor/s run.
 - E. Check earth connections.

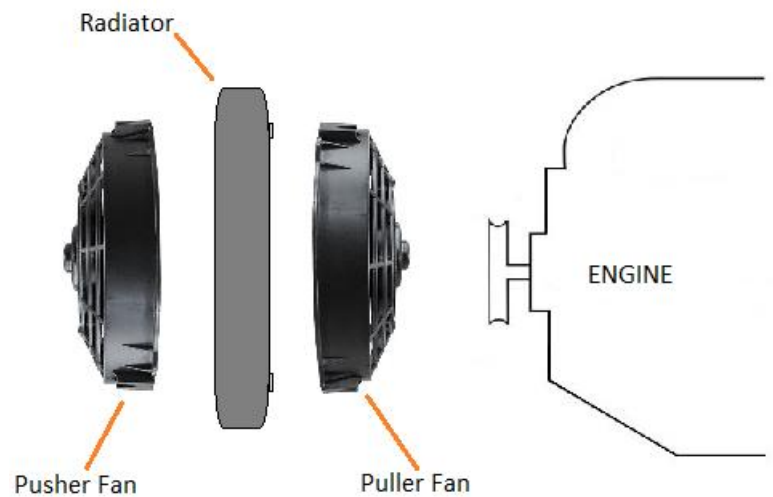

AF49-1029 Fan Controller (sold separately)

AF49-1049 Heavy Duty Fan Mount (sold separately)



AF49-1006 Fan Relay (sold separately)

For more information or technical enquires

Contact: Aeroflow Performance on

Phone: (02) 8825 1979 Website: www.aeroflowperformance.com